

# STRATA

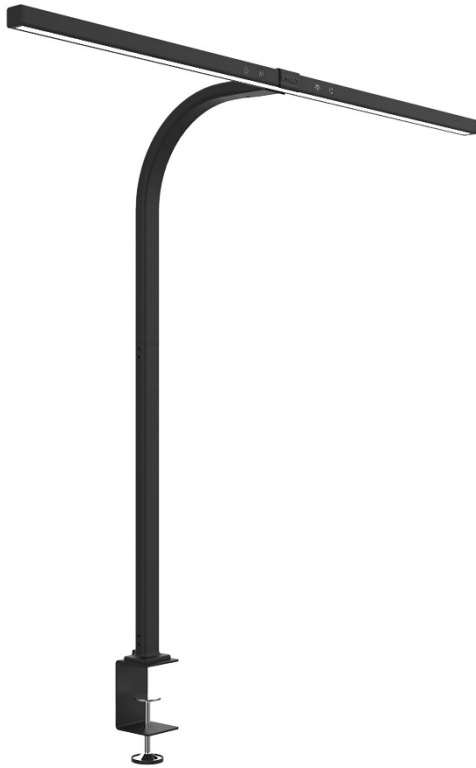

- **Asymmetrical lighting:** equipped with asymmetric lighting that neutralizes much of the glare and greatly increases the area illuminated. **Innovation:** a new generation of ergonomic desk lamp that offers great light amplitude, quality custom lighting and reduces eye strain.
- **Optimum visual comfort:** thanks to its flexible arm STRATA adapts to the height and size of your screens.
- **Modern design lamp:** its innovative, slender, airy and refined design will sublimate your office interior.
- **Variation of light intensity and color temperature:** on its head, two touch switches allow to vary the light intensity and another to adjust the color temperature. Adapt your lighting according to your activity (rest, reading, work).
- **Intelligent:** depending on the ambient light of your workspace, the lamp adapts its light for a better visual comfort, thanks to its brightness sensor
- Rated power: this luminaire contains integrated LED lamps with a power of 12,7 W that can not be replaced
- Lifespan \* of LEDs: 50,000 hours
- Illuminance of 1170 Lux at 50 cm
- Color temperature: 3000 K to 6000 K
- Weighted energy consumption: 10,6 kWh / 1000 h
- Luminous efficiency \*\* of LEDs: 100 lm / W
- Energy efficiency: class A / A+ / A++ (spectrum A++ to E)
- CRI: 82
- 2 years warranty
- Maximum height: 70 cm / minimum height: 50 cm
- Materials: high quality steel clamp (maximum spacing 8 cm) / aluminum arm and rubber-coated metal / aluminum head

\* Average consumption: 1000 h / year  
 \*\* Light emission of the lighting source

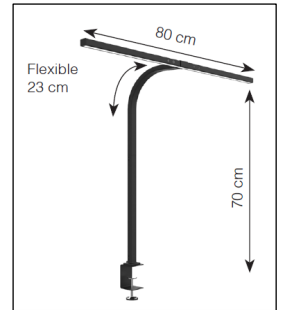
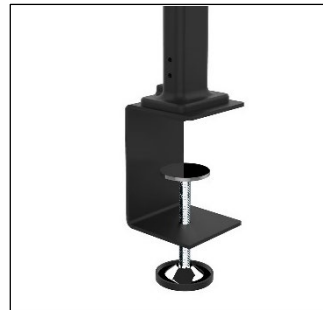
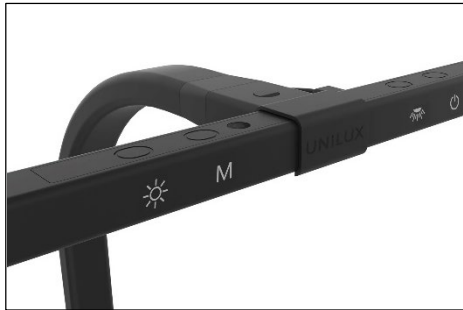

## Technical features

Measurement of Lux on the worktop in 50 cm top view:

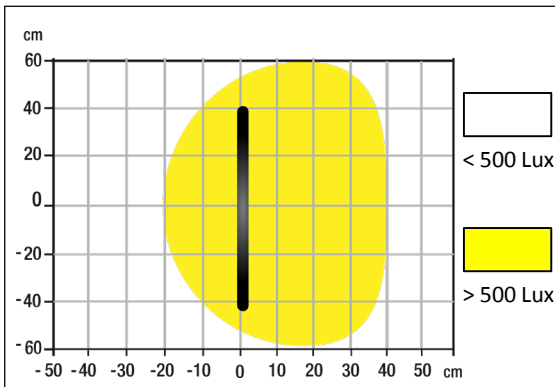

Measurement of Lux on the worktop in 50 cm top view:

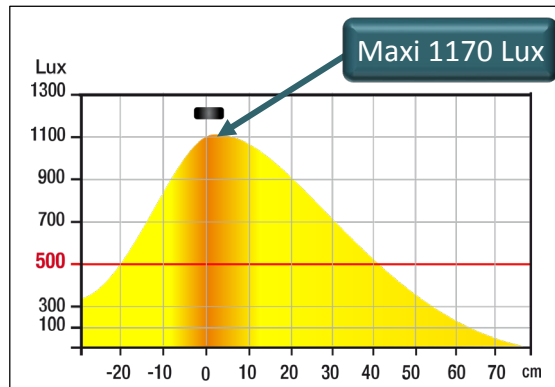

Energy class:

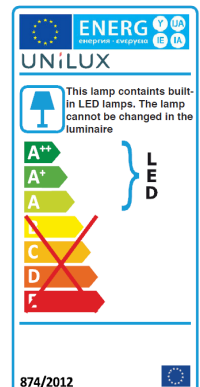

SAP no.	Colours	Energy consumption kWh/1000 h	Lm	Lm/W	Colour T°	CRI	Source's lifetime	Warranty	Net weight	EAN code
400124562	Black	10,6	1170	100	3000 K to 6000 K	82	50000h	2 years	1,19 kg	3595560029525

# UNILUX'S ADVICES

## 1- Why using a desk lamp ?

We spend about 8 hours a day at our place of work. Occupational medicine **recommends lighting of at least 450 lux**. The European standard NF EN 12464-1 \* **goes up to 500 lux** for screen work or reading. You should know that an office equipped with fluorescent ceiling lights usually receives **200 and 300 Lux** for those in LED!

**The consequences of constant and insufficient artificial interior lighting:**

- **Decreased visual comfort**
- **Headache**
- **Badly lapping the general concentration**
- **Decrease in productivity**
- **Disturbances of the circadian cycle**
- **Sleep and mood disorders**

\* Standard NF EN 12 464-1 (European standard): Requirement for lighting indoor workplaces

## 2- Some figures



**300 Lux**

Only on the desk fitted with ceiling lights



**34% of offices**

Reach the level of 500 Lux prescribed by Occupational Medicine



**29 % of employees**

Report suffering from eyestrain \*

\* Source: <http://www.recrutons.fr/ergonomie-du-poste-de-travail.html>

## 3- The LED's Benefits



**High quality and efficient lighting**



**Longer life**



**Energy saving**



**Eco-responsible purchase**



**Safe for the health**

## 4- Somes definitions

### Illuminance (Lux)

corresponds to a quantity of light received by a surface. So:

- $\Phi$ : Luminous flux in lumen
- S: surface per m<sup>2</sup>

$$E = \frac{\Phi}{S}$$

Recommended lighting according to DIN EN 12464-1 \* for the office

- 300 Lux : deposit, copy, traffic areas
- 500 Lux : writing, reading, data processing
- 500 Lux : at the reception and at the counter
- 750 Lux : technical drawing

\* DIN EN 12464-1 (DIN 5035-1): European standard that determines the lighting requirements of workstations in enclosed areas, which meet the requirements of comfort and visual performance. DIN EN 12464-1 has replaced DIN 5035-1

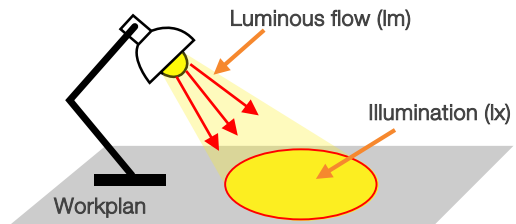

### Luminous flux (lm)

is defined by the sum of all the radiations emitted by the lamp. It is measured in Lumen, "lm" for short. It is defined from the energy flux (expressed in watts) more often termed radiated power.

The latter is a flow of radiated energy:

$$\Phi = \frac{Q}{t}$$

where Q is the radiated energy, expressed in joules (J) and t in seconds (s)

### Luminous efficiency (lm/W)

corresponds to the luminous efficiency of the lamp. This value is established by the ratio between the luminous flux and the power consumed. It is measured in "lm / W". The higher the luminous efficiency, the higher the amount of light relative to the power consumed. This data is fundamental for the preservation of the environment since it allows us to reduce energy consumption for the same amount of light emitted.

### Color temperature (Kelvin)

is defined by the color emitted by the light source. Variation in color temperature is an essential function of the desk lamp in addition to the variation of the intensity, as it allows to customize the lighting and to adapt the appropriate color temperature to the different activities (computer work, concentration, reading, relaxation, rest, ...). This variation in color temperature is measured in "Kelvin", "K" for short.

